

## One Year Full Warranty

Your butane powered heat tool was carefully tested and inspected before it was shipped from the factory. We warrant this product to be free from defects in materials and workmanship under normal use and service for one year from date of purchase. In the event of a defect in materials or workmanship, we will either repair or replace, without charge, at our option, any part which in our judgement shows evidence of such defect.

This warranty does not apply to the attachments, tips, burner, or ejector, which are items requiring periodic replacement, nor does it apply if the butane powered heat tool has been misused, abused, altered, tampered with, or used with butane fuel other than Master Appliance Ultratane butane fuel. At the end of the warranty period, Master Appliance shall be under no further obligation, expressed or implied. Some states do not allow limitations on how long an implied warranty lasts, so the above limitation may not apply to you.

Master Appliance assumes no responsibility for and this warranty shall not cover any incidental or consequential damages from any defect in this product or its use. Some states do not allow the exclusion or limitation of incidental or consequential damages, so the above exclusion may not apply to you.

This warranty gives you specific rights and you may also have other rights which may vary from state to state. For warranty repair a proof of purchase receipt or other appropriate proof of date is required with your return for warranty repair to Master Appliance. All warranty claims must be made to Master Appliance and not the distributor. We decline responsibility where repairs have been made or attempted by others. Any different guarantee made by others is not authorized by us. If a warranty claim is to be made please return your Master Heat Tool prepaid, with proof of purchase and a note describing the problem to our Repair Department. See below. For repair service we charge a flat rate fee. Please call Master Appliance for the flat rate charge. return your Master Heat Tool prepaid, with a note describing the problem to:

**1.WARNING:**This product, when used for soldering and similar applications, produces chemicals known to the State of California to cause cancer and birth defects or other reproductive harm.

**ADVERTENCIA:**El estado de California tiene conocimientos de que este producto, cuando se usa en soldaduras o aplicaciones similares, produce agentes quimicos que pueden provocar cancer, defectos congenitos y danos al sistema reproductor.

**2.WARNING:**By-products of the combustion of the fuel used by this product contain chemicals known to the State of California to cause cancer and reproductive harm.

**ADVERTENCIA:**El estado de California tiene conocimientos de que los productos residuales de la combustion del combustible usado por este producto, contiene sustancias quimicas que pueden provocar cancer y danos al sistema reproductor.

**3.WARNING:**The Department of Transportation Hazardous Material Regulations forbid the carriage of butane or other flammable gas products on passenger aircraft. Do not pack this item or any other flammable gas item, in any checked or carry-on baggage.

**MASTER**<sup>®</sup>  
**APPLIANCE**  
Designers and Manufacturers  
of Heat Tool for Industry

Master Appliance Corp.  
2420-18th Street  
Racine, WI 53402 U.S.A.  
Tel: (262) 633-7791  
Facsimite: (262) 633-9745  
web: www.masterappliance.com  
e-mail: sales@masterappliance.com

Please ship tool prepaid. Enclose a note describing your problem.

Rev. 2  
Made in Japan

# MINI ULTRATORCH<sup>®</sup> UT-50



Please read, understand and keep this manual for future reference

## Operating Instructions

- Unit operates on butane gas and creates infrared heat effectively by the use of a catalyst.
- Before filling, make sure switch ring is off.
- Press the nozzle into the refill opening. When the unit is full, the gas will overflow the refill nozzle.
- Check the window for fuel level.

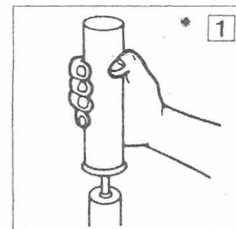

**NOTICE:**Before igniting your Ultratorch the first time, completely fill the tank with butane. Then wait 5 minutes. During this time tilt the Ultratorch up and down several times. This initial waiting period gives the wick inside the fuel tank time to absorb the butane and allows for lubrication of the filter.

## Soldering & Heat Tool Instructions

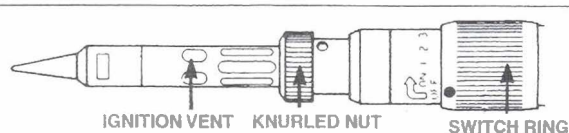

### Ignition Instructions

1. Push the switch ring up and turn to the right. Place the indicator dot on 1 or lower.
2. Push the knurled nut upward exposing the ignition vents.
3. Ignite as shown by Figure 3, keeping the vent open. Hold knurled nut until glow appears from catalyst. Release the knurled nut, which will return to its original position.
4. The heat of the soldering tip can be controlled by rotating the switch ring between position 1 and 3.

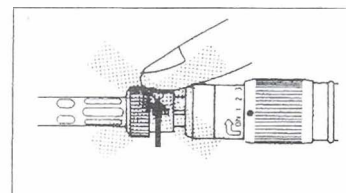
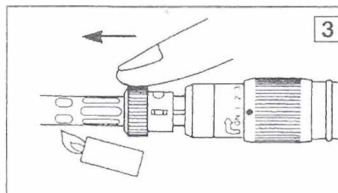

## Butane Torch Instructions

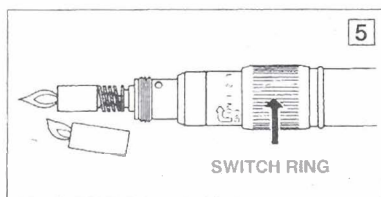
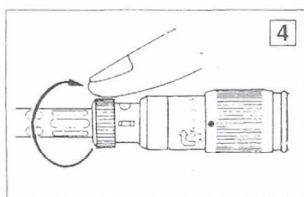

1. Loosen and remove tip by turning the knurled nut to the right as shown in Figure 4.
2. Push the switch ring up and turn to the right until the indicator dot is on 1 or lower.
3. Ignite as shown by Figure 5.
4. Adjust the flame length by rotating the switch ring between position 1 and 3.

## Optional Parts Available

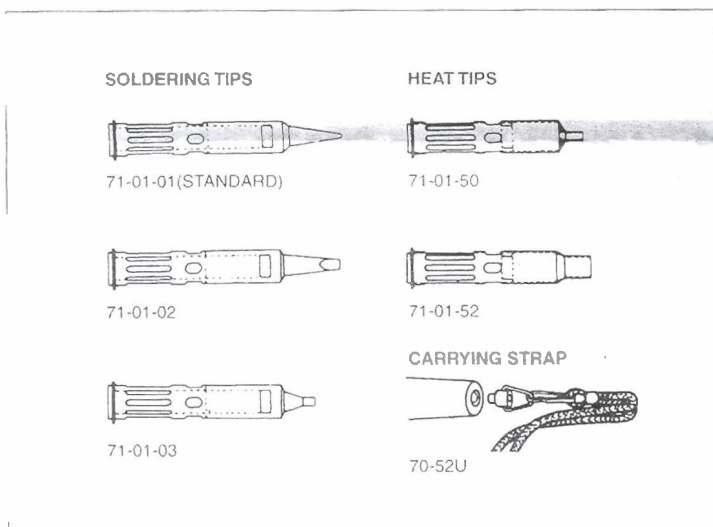

**NOTE:** Attach the carrying strap by inserting it into refill nozzle opening and turning right till tight.

## Safety Tips & Storage

1. Avoid filling in areas where flames are present.
2. Be sure to turn switch ring "off" after use. Keep protective cap on unit when not in use.
3. Do not use alcohol or alcohol base cleaner on fuel window.

4. **CAUTION:** Temperature is high at tip area. Wait for tips to cool before changing. Keep hands and combustibles from tip area while in use.

5. Do not immerse heated parts in water; allow to cool naturally.

6. Use only butane gas specified by manufacturer. Do not use propane gas or any other types of fluids.

7. Do not store in temperatures over 40°C/104°F.

8. Do not store in a car during periods of high temperatures as fuel tank could possibly rupture.

9. Store away from children.

## Trouble shooting

TROUBLE	CAUSE	SOLUTION
DOES NOT IGNITE	1. Empty fuel 2. Ejector nozzle is clogged 3. Fuel setting too high	1. Refuel 2. Loosen retaining ring, screw out ejector & replace. 3. Reduce the fuel setting on the switch ring.
LOW GAS PRESSURE LOW FLAME	1. Foreign object blocking tips. 2. Cold fuel 3. Low fuel	1. Clean out or replace tips. 2. Hold in handsto allow unit to warm up. <b>DO NOT HEAT HANDLE.</b> 3. Refuel
NOT ENOUGH HEAT	1. Used-up catalyst 2. Low fuel	1. Purchase new tip 2. Refuel

**NOTE:** The Mini-Ultratorch UT-50 utilizes the energy produced while evaporating butane gas. Ambient temperatures affect operation. Adjust the unit as necessary.

## Specifications

Size/without cap	165 mm
with cap	173 mm
Weight/with full tank	56.6 g
empty	53 g
Soldering Iron equivalent to 80 watt electric soldering iron	200-450°C/392-842°F
Flameless Heat Tool	430°C/806°F max.
Butane Torch	1300°C (2372°F) max.
Operating Time/full tank	Approx. 20 min.

Specifications may change without notice.